

Article number: 2314452793

Description: E+G polyurethane wheel 452793  
RE.G5-85x40-RSL - Loose wheel with ball bearings

## Measures

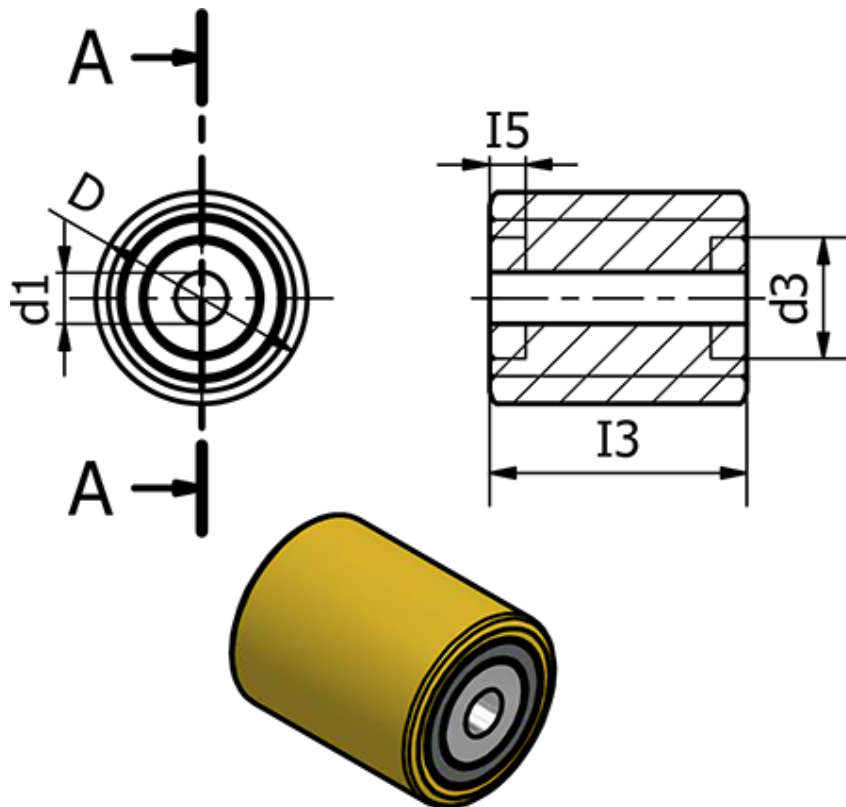

Code	= 452793	Static load (N)	= 4500
D	= 85	Type	= RE.G5-85x40-RSL
d1	= 20	Weight (g)	= 720
d3	= 47		
Dynamic carrying capacity (N)	= 4000		
I3	= 40		
I5	= 14		
Rolling resistance (N)	= 1500		